

# Armstrong's Point Heritage Conservation District Plan

Initial Draft June 2017, HTFC Planning + Design

Updated fall 2018 and early 2019 by City of Winnipeg  
to align with requirements of HCD By-law 87/2018.



## Table of Contents

1.0 Introduction

2.0 Interpretation

3.0 History and Evolution

4.0 HCD Objectives

5.0 Statement of Significance

6.0 Heritage Permits

7.0 Heritage Conservation District Policies and Guidelines

8.0 Armstrong's Point HCD Advisory Committee Terms of Reference

9.0 Community consultation results

## 1.0 Introduction

*“The recognition of local distinctiveness in the form of conservation areas...is not a device for preventing change or new development. Every conservation area contains places which have changed. Often these changes are the features of the character which we wish to protect. Often, too, further changes have to be accommodated if we are to ensure such places have a viable and beneficial future.”* [English Heritage: Valuing Places – Good Practice in Conservation Areas, 2014]

Well-managed change can bring with it the investments and care necessary to maintain and enhance areas of historical significance. The care of our built inheritance “has to be carefully balanced with the economic and social imperatives of the present” (English Heritage).

Through Council approval of the Heritage Conservation Districts By-Law No. 87/2018 (the “HCD By-law”) on September 20, 2018, The City of Winnipeg (“The City”) established a process to designate Heritage Conservation Districts (“HCD”) and guide change in these areas of historical significance.

This Heritage Conservation District plan in respect of Armstrong’s Point (the “Plan”) builds on the findings and outcomes of the Armstrong’s Point HCD study (the “Study”, c.2016, updated 2018). The Study was based on historic research, review of other jurisdictions, and stakeholder consultation, and was officially approved as part of the process outlined in the HCD By-law on February 4, 2019.

In addition to historic information and results from community consultations, the Plan is made up of the following regulatory components: a statement of significance (with HCD boundaries, neighbourhood description, heritage values, and character-defining elements of the neighbourhood), HCD objectives, policy guidelines, a list of work for which a heritage permit is not required, and terms of reference for an HCD Advisory Committee. These plan components were developed in consultation with community residents, and comply with requirements found in the HCD By-law.

Additional historic and architectural overviews, as well as a full summary of stakeholder consultation for the Study and the Plan, can be found in the Study.

## 2.0 Interpretation

### 2.1 Policy Interpretation

Should there be any inconsistencies between an objective and a policy stated in this HCD, the policy shall take precedence. Each paragraph, sentence or clause that is a policy statement, or portion thereof, is numbered.

Where the word “may”, “encourage”, “discourage”, or other similar word, is used in a policy, that policy is provided as a guideline or suggestion toward implementing the intent of the policy.

Where the word “shall” or “must” is included in a policy, the policy is considered mandatory.

Where the word “should” is used in a policy, the policy is intended to apply to a majority of situations. However, the policy may be deviated from in a specific situation where the deviation is necessary to address unique circumstances that will otherwise render compliance impractical or impossible, or to allow an acceptable alternate means to achieve the general intent of the policy.

### 2.2 Image Interpretation

Images, figures, and visual aids are included in this Plan for convenience of reference only.

## 2.3 Definitions

In this Plan, the following words and phrases have the following meanings:

- (a) “**auto court**” means a lot configuration regulated under subsection 140(2) of the Zoning By-law;
- (b) “**accessory building**” means a structure that is subordinate or incidental to, and located on the same zoning lot as, a principal building;
- (c) “**alteration**”, in respect of a property within the Armstrong’s Point HCD, means any change that will or may affect one or more character-defining element of the property;
- (d) “**built heritage resource**” means a building or structure that contributes to a property’s heritage value or interest as identified by a community;
- (e) “**character**” means the overall physical features and visual qualities that make an area distinct from its surroundings;
- (f) “**character-defining element**” means the elements of a property that contribute to the heritage value of that property and that must be retained in order to preserve that property’s heritage value, including but not limited to
  - (i) the property’s built or manufactured elements
  - (ii) natural landforms;
  - (iii) vegetation;
  - (iv) water features; and
  - (v) building materials, form, location, spatial configuration, use and cultural associations or meaning;
- (g) “**Conservation**” has the same meaning as in the *Standards and Guidelines for the Conservation of Historic Places in Canada*;
- (h) “**flag lot**” means a lot configuration regulated under subsection 140(4) of the Zoning By-law;
- (i) “**heritage value**” means the aesthetic, historic, scientific, cultural, social or spiritual significance of a property for past, present or future generations;
- (j) “**loop lane**” means a lot configuration regulated under subsection 140(3) of the Zoning By-law;
- (k) “**principal building**” means the building on a zoning lot which contains, houses or shelters the principal use of that zoning lot;
- (l) “**street**” has the same meaning as in The City of Winnipeg Charter, SM 2002, c. 39;
- (m) “**Zoning By-law**” means the Winnipeg Zoning By-law No. 200/2006; and
- (n) “**zoning lot**” has the same meaning as in the Zoning By-law.



## 3.0 History and Evolution

### 3.1 Overview

Armstrong's Point is a well-established and intact example that reflects its original residential development pattern. The area's history, architecture, cohesive streetscapes and natural landscape contribute to its being a highly valued urban district that is worthy of recognition and protection.

The early development pattern of Armstrong's Point is still highly visible today, even though the area has evolved with the ongoing subdivision of the original lots. The cultural values of the district lie in its historical associations with many aspects of the city of Winnipeg's 20th century development. Its original development as a "picturesque" residential area for the city's early elite, followed by its waning due to declining economic conditions in Canada; the rise in property tax levels which led to the subdivision of some of the individual homes and lots; the renewed development of modest residential buildings through the post-World War II era, and finally to the present and a renewal of the neighbourhood's desire to preserve the best aspects of their community.

The development of the residential stock in the area is an encyclopaedia of the styles (ornamentation and mass) illustrative of the North American domestic residential design trends from the 1880s through to the 21st century.

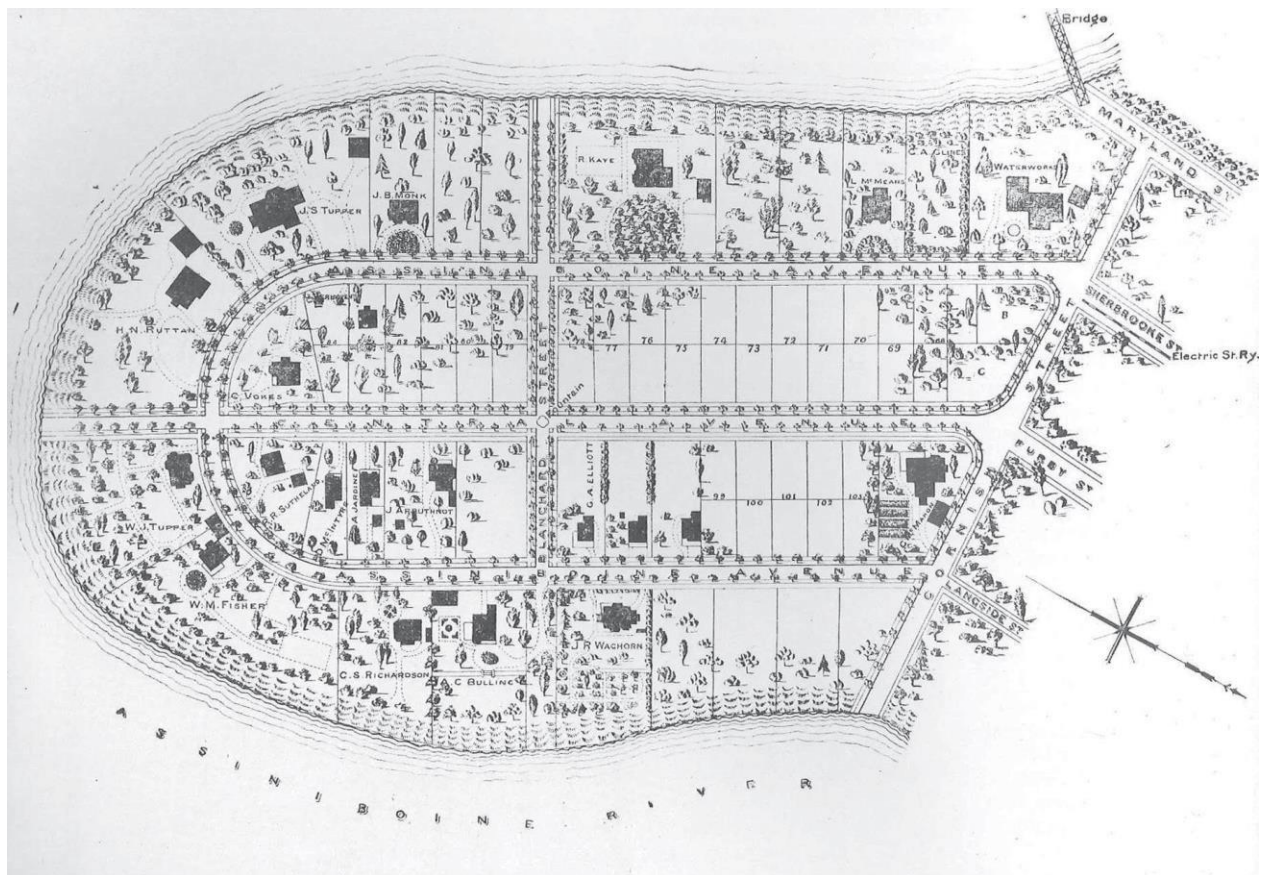

Map of Armstrong's Point c. 1903

### 3.2 Historic Timeline

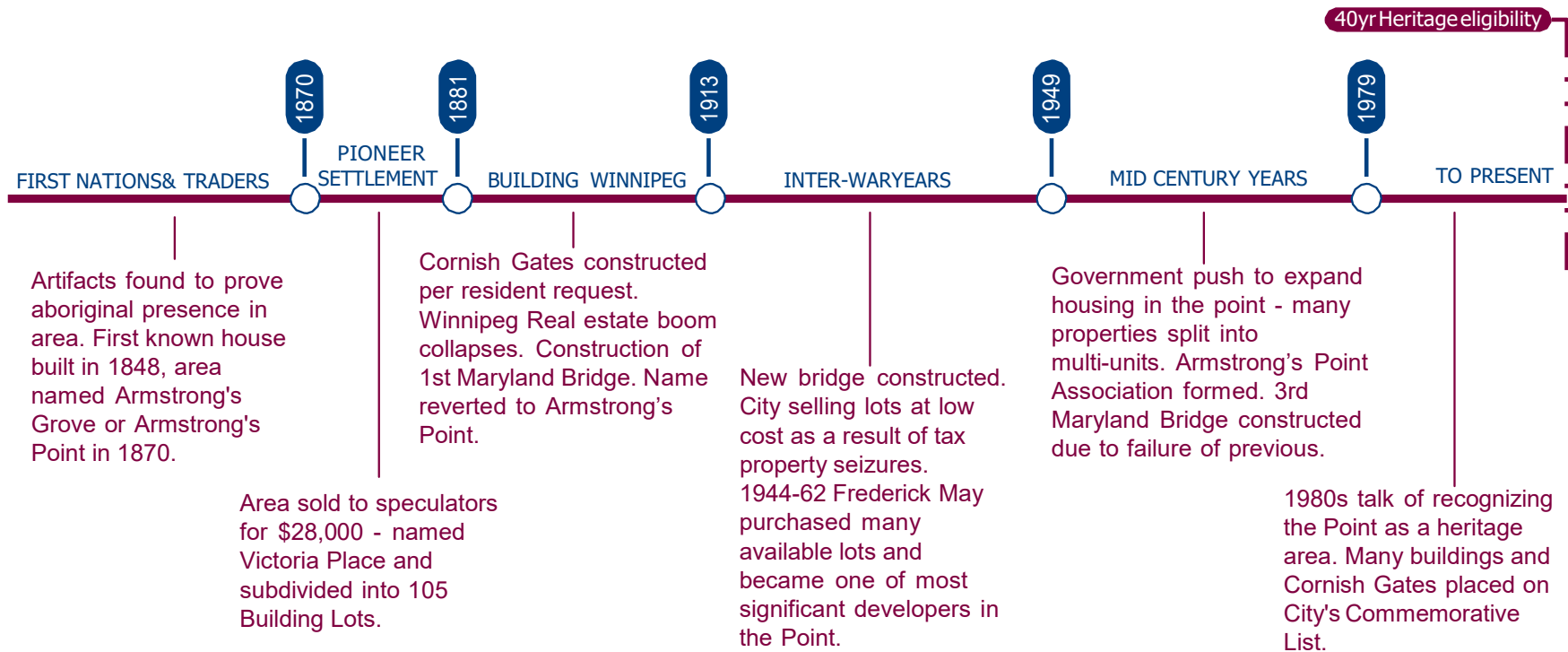

### 3.3 Key Development Eras

The development eras in the following figure show the transformation in the occupation of the Point, the changing economic times in Winnipeg, and thus the Point, the variation in the type of homes built in the area, and finally the ongoing pursuit of Winnipeggers and the local residents to conserve this neighbourhood's unique qualities

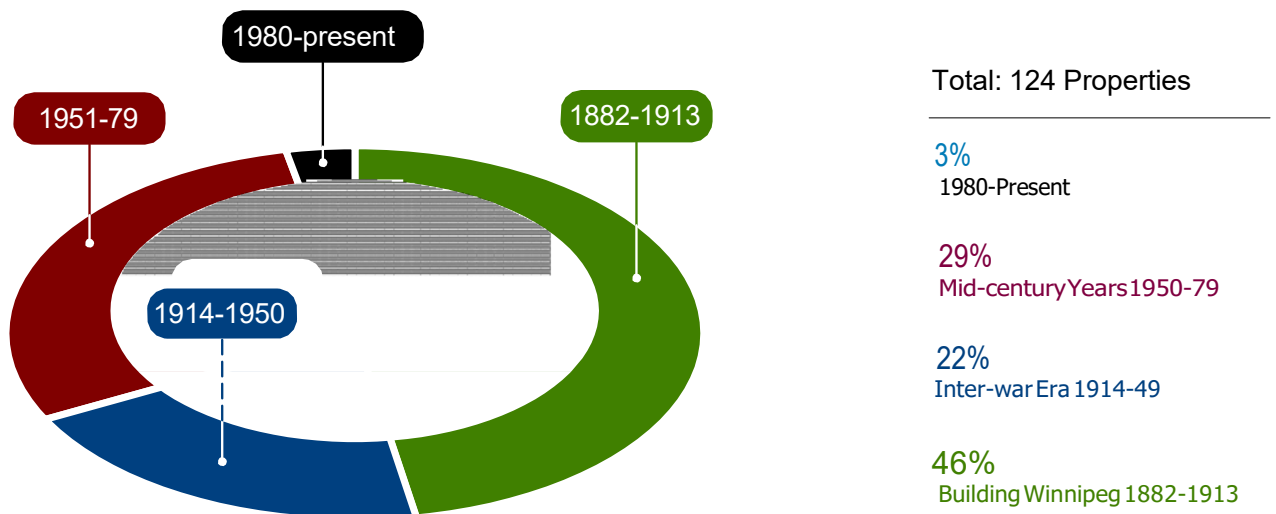

*Properties constructed per Development Era*

### 3.4 Historic Designation and Commemorations

Several individual buildings and structures in Armstrong's Point have been designated historic under the "Historical Resources By-Law" No. 55/2014. These include:

- Ornamental entry gate features (Cornish Avenue right-of-way at East Gate, Middle Gate, West Gate);
- Cornish Library (20 West Gate);
- Ralph Connor House (54 West Gate; also federally- and provincially-designated); and
- Monk Residence (134 West Gate)
- Other buildings on the City of Winnipeg's Commemorative List can be found at [Winnipeg.ca/ppd/heritage](http://Winnipeg.ca/ppd/heritage).

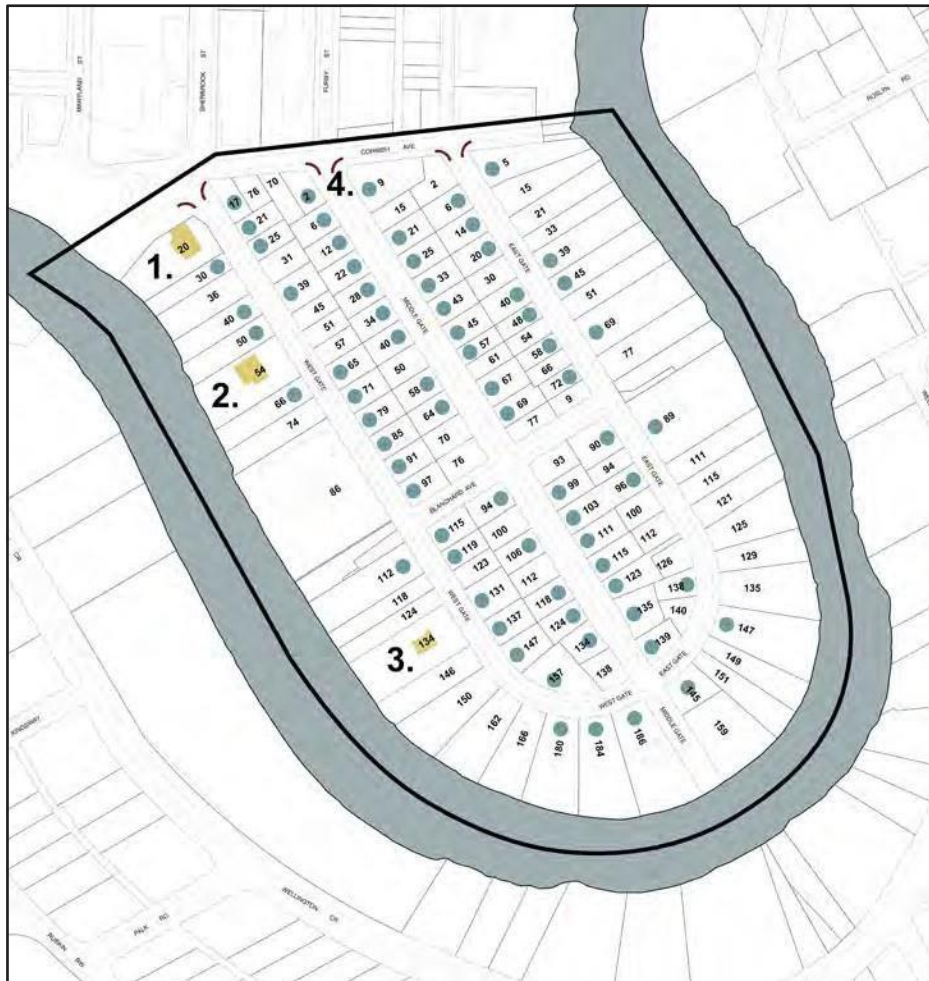

Historical Resources in Armstrong's Point:

1. Cornish Library
  2. Ralph Connor House (also National Historic Site)
  3. Monk Residence
  4. Ornamental Gates
- On the City of Winnipeg's Commemorative List



## 4.0 HCD Objectives

### 4.1 Intent

Winnipeg does not intend to prevent change within the district or neglect potential effects of individual or cumulative changes within the district. As with designated districts in other cities, Armstrong's Point includes places within its boundaries that have changed; further changes are anticipated in Armstrong's Point. The intent of the HCD Plan is rather to accommodate and manage this change to ensure the district has a viable future, based on guidance that encourages the investment and care necessary to sustain Armstrong's Point and its constituent parts in good condition and in response to evolving economic, social, and environmental factors.

### 4.2 Objectives

While the Standards & Guidelines are expected to provide the foundation for the management of change within all of Winnipeg's HCDs, each HCD will have guidelines tailored to fit its unique needs. In managing change within its boundaries, the Armstrong's Point HCD policies and guidelines have been introduced to achieve the following objectives:

#### 4.2.1 Primary Objective

The primary objective for every Winnipeg HCD is the identification, protection, celebration, and management of the district's attributes and heritage resources so that the area's historic significance, heritage values, and character as identified in the HCD study and HCD plan are protected in the long- term.

#### 4.2.2 District-wide Objectives

The following objectives apply in respect of the Armstrong's Point HCD as a whole:

- (a) to protect and celebrate Armstrong's Point's character and heritage resources;
- (b) to encourage the ongoing use and adaptive reuse of existing building stock and infrastructure;
- (c) to conserve the distinct heritage character of the district;
- (d) to manage the tree canopy, individual specimen trees, and planted boulevards
- (e) to encourage the establishment of those land uses and associated built forms that individually would be in keeping with the district and cumulatively would have beneficial impacts on the district's character; and
- (f) to confirm the recommended heritage conservation district boundaries.

#### **4.2.3 Streets and Public Open Spaces Objectives**

The following objectives of the Armstrong's Point HCD apply in respect of streets and public open spaces within the HCD:

- (a) to retain and enhance opportunities for public access to/from the riverbank at street ends and at municipally-owned properties; and
- (b) to respect the characteristic public right-of-way cross-section – narrow travel lanes, public sidewalks, grassed boulevard with space for street trees and utilities; with an emphasis on pedestrian comfort and on walkability.

#### **4.2.4 Individual Property Objectives**

- (a) The following objectives of the Armstrong's Point HCD apply in respect of individual properties within the HCD:
- (b) to avoid the loss of individual heritage buildings and structures and of specific streetscapes and landscapes;
- (c) to encourage ongoing repair and maintenance of properties and ensure that such work is undertaken in a manner that does not diminish the essential form and integrity of the HCD;
- (d) to ensure new buildings and additions to existing buildings are consistent with the HCD's heritage values;
- (e) to ensure new buildings and additions to existing buildings do not have a detrimental effect on the riverbank's stability or on the riparian area;
- (f) to recognize the diversity of building styles, materials, and construction dates;
- (g) to protect the pattern of prominent principal buildings and the subordinate relationship of accessory buildings and service functions to them, particularly in terms of respecting the characteristic view of private properties from the street;
- (h) to protect the building placement within a lush landscaped garden setting as a unifying element in the district; and
- (i) to recognize the high number of architect-designed houses.

## 5.0 Statement of Significance

### 5.1 Introduction

Armstrong's Point is an intact example of an early Winnipeg residential neighbourhood. Though initially designed and subdivided in the late-19th century, its building stock has continued to evolve throughout the 20th and into the 21st century. Armstrong's Point's history, architecture, cohesive streetscape and natural landscape contribute to its recognition as a highly valued urban district that is worthy of protection.

The development of the Armstrong's Point's building stock is a pattern book of domestic forms and styles illustrative of North American residential design trends from the 1880s through to the 21st century. Armstrong's Point is a dynamic district, one that integrates successive periods of construction and retains evidence of each period.

### 5.2 Neighbourhood Description

Armstrong's Point is primarily a residential neighbourhood located southwest of Downtown Winnipeg on a 21.8 hectare meander along the north side of the Assiniboine River. The Hudson's Bay Company originally granted the property to Captain Joseph Hill in 1848. After some fits and starts, houses were built during the 1880s, many Victorian in style. Initially, Armstrong's Point was considered more of a summer residential area for "the country set of Winnipeg's commercial elite". By 1904, 20 houses had been built. Construction continued over the years, with the majority of houses built between 1910 and 1920; some mid-century modern following World War II; and further additions as recent as 2012.

Armstrong's Point includes ornamental gateway features built in 1911, at the East, Middle, and West Gate entrances along Cornish Avenue. The Assiniboine River and a dense riparian forest wrap around the neighbourhood. The streets are regularly tree-lined and individual properties are well-treed. The majority of its 124 lots are single-family residences, plus a library, a school, a private club, several duplex and triplex conversions, and some bed & breakfast operations. Publicly accessible green spaces offer views to the river.

The building stock, street layout, and vegetation are relatively intact and reflect the original development pattern, which gives this district a distinct identity within Winnipeg. The area's history, architecture, cohesive streetscaping and natural landscape contribute to its being a highly valued urban district that is worthy of recognition and protection.

Armstrong's Point is close to Downtown Winnipeg, the Sherbrook-West Broadway business area, and the Misericordia Hospital. Adjacent neighbourhoods include: West Broadway (north); Wolseley (west); and the Crescentwood, McMillan, and Roslyn cluster across the river (south).

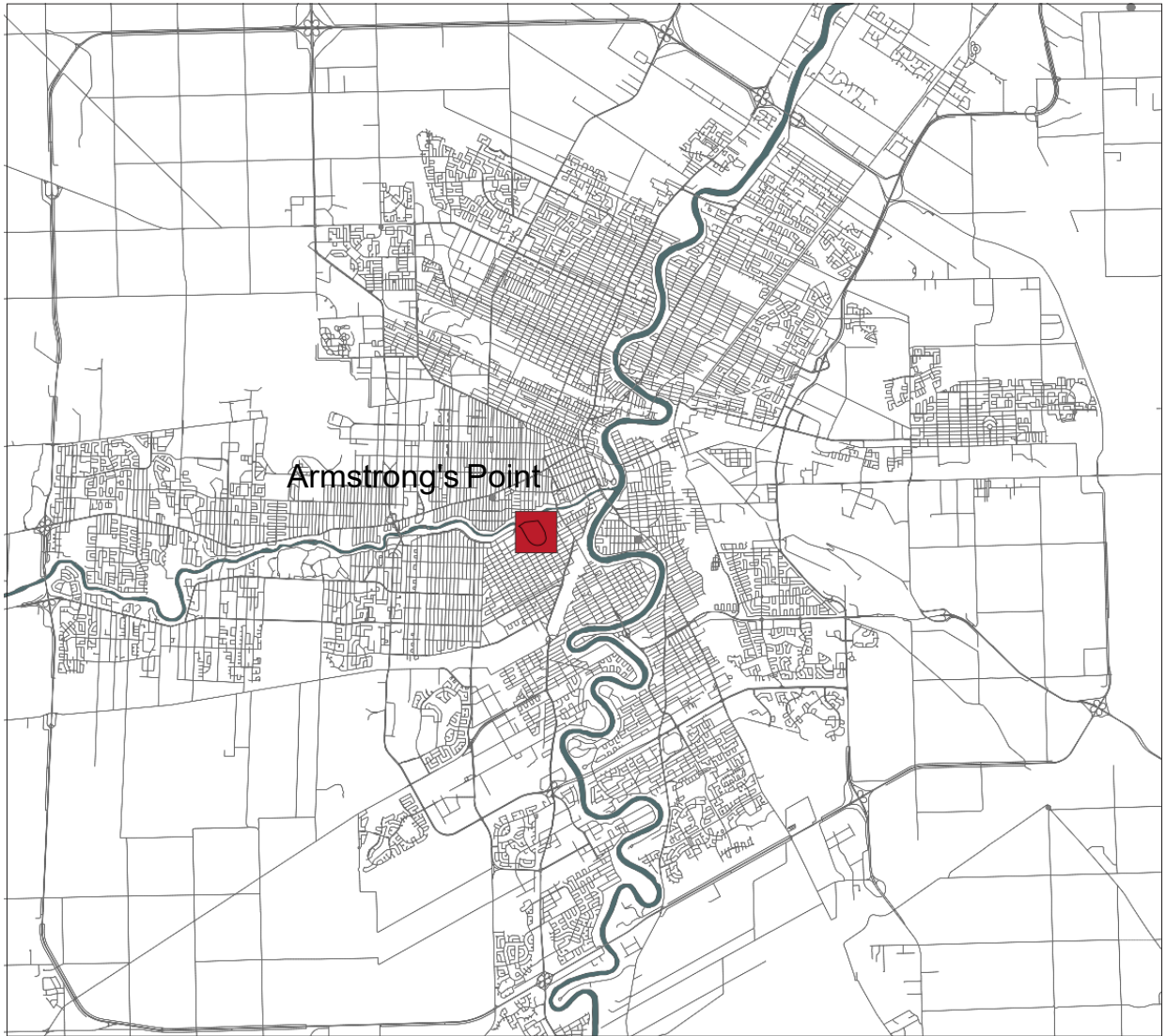

*Armstrong's Point within City of Winnipeg*



### 5.3 District Boundaries

The Armstrong's Point Heritage Conservation District includes all properties within these boundaries: From the north boundary of Cornish Avenue right-of-way at Sherbrook Street, east to the midpoint of the Assiniboine River, continuing south and following the midpoint of the Assiniboine River around to the south boundary of the Maryland Bridge/Sherbrook Street right-of-way, north east along the north boundary of the Cornish Library property to its intersection with the north boundary of Cornish Avenue at Sherbrook Street, with all of the ornamental gates included within the district boundaries.



*District Boundary Recommendation*



## 5.4 Heritage Values

Armstrong's Point has continued to grow and change over decades of evolution, folding examples of successive years of domestic architecture into its original pattern, initially designed in the 1880s. Armstrong's Point as a whole exhibits characteristics of a designed and dynamic district.

Although the district contains recently-built properties that may not qualify as historical resources on their own, a majority of buildings contribute to the heritage value of the Armstrong's Point HCD. It is not uncommon for HCDs to contain contemporary buildings that co-exist with heritage resources. All resources, as part of the evolution of the district, will be subject to the Plan's policies and guidelines for the management of all district resources.

Armstrong's Point embodies the following heritage values:

- it is an intact, primarily residential neighbourhood, over a century old;
- it is Winnipeg's first suburb;
- it was envisioned as a neighbourhood with large lots, many large homes, and ornamental gateway features;
- many of the residences were originally built and occupied by Winnipeg's founding families;
- Armstrong's Point is distinct from neighbouring areas, bound by the Assiniboine River and ornamental gateway features;
- Much of its early building stock, constructed between 1882 and 1930, remains intact;
- where non-residential uses have been added, they have been integrated into residential buildings, with few exceptions;
- Three buildings and the ornamental gates are listed on the City of Winnipeg's Historic Resources List, one of which is also a National Historic Site (Ralph Connor House);
- Seventy-one (71) buildings are listed on the City of Winnipeg's Commemorative List.

## 5.5 Character-defining elements

The buildings, streetscape, and landscape features visible today are evidence of more than 140 years of development and ongoing occupancy spanning three centuries, with each period adding to the district's overall visual coherence. Armstrong's Point displays a great deal of variation in its built heritage; many different periods are represented in the styles, materials, rooflines, form, and massing of the architecture. Despite the variations in the built form, a harmonious composition is created by the careful placement of buildings within a spacious and green streetscape. Both the private settings of individual lots and the public realm of wide grass boulevards along tree-lined streets create a cohesive visual character of outstanding heritage value.

The character-defining elements of Armstrong's Point are:

- (a) District is located in a meander of the Assiniboine River, bounded by the river along all but its north side, with Cornish Avenue forming its north boundary, and separated by formal ornamental iron and decorative stone gates built at its three street entrances;
- (b) The scale and form of buildings, with heights from one- to three-storey;
- (c) Buildings are predominantly residential and feature a variety of architectural styles, materials, and details that are evidence of construction activity from many periods; a majority of buildings were constructed between 1880 and 1930;
- (d) Deep setbacks of buildings from the street, with the setback area generously landscaped with lawn or planting areas but with front entrances visible from the street;
- (e) Spacious lots with a high percentage of soft landscaping in contrast to building or paved surfacing, many with river access;
- (f) The boundaries of many private lots defined with ornamental fencing or hedges and frequently marked by brick or stone pillars;
- (g) Well-defined geography – tree-lined, paved, curbed roads wrapping around the neighbourhood, with generous grass boulevards and sidewalks integrated with the street trees;
- (h) Public open spaces include views to the river and riparian areas; and
- (i) Notable urban forest with old-growth vegetation, including many documented pre-settlement specimens.

## 6.0 Heritage Permits

### 6.1 General Information

The focus of the Plan's policies and guidelines is on guiding changes in the district, specifically those within the public street rights-of-way and on those portions of private and public properties visible from these streets.

Subject to the exemptions outlined in this section, owners of property located within the district are required to obtain a heritage permit in accordance with the HCD By-law. All works that require a heritage permit must be designed, reviewed, installed, constructed, and maintained in accordance with section 5: "Heritage Conservation District Policies and Guidelines".

Irrespective of whether a heritage permit is required or not, all works must comply with all applicable municipal, provincial, and federal policies, by-laws, and codes in effect at the time, including but not limited to the *Neighbourhood Liveability By-law*, the *Vacant Buildings By-law*, the *Winnipeg Building By-law* and the *Development Procedures By-law*. Depending on the location and complexity of proposed changes, multiple approvals (e.g. Heritage Permit, Building Permit, Waterway Permit) may also be necessary.

Where demolitions or removal of character-defining elements are contemplated, applicants must submit permit drawings and information that include details of new buildings or modifications to existing buildings.

Plans for major works such as demolition or new housing construction should also be accompanied by evidence of community consultation with nearby property owners as well as the wider Armstrong's Point community.

Applications for other modifications to house exteriors visible from the street should be accompanied by evidence of consultation with surrounding property owners.

The designated employee is authorized to recommend or require additional consultation as he or she deems necessary.

As with any modifications, it is beneficial to contact the Heritage Planner to discuss proposals before commencing work within the district to establish how the Plan's policies and guidelines affect their property and its potential for development. Some of the proposed modifications may also require approval in accordance with other by-laws or codes; in these cases, relevant agency representatives should also be contacted.

## 6.2 Work Not Requiring a Heritage Permit

Notwithstanding section 5 of the By-law, the following types of work are considered minor in nature and accordingly no heritage permit is required. Even where a heritage permit is not required, property owners and those working on the owners' behalf are encouraged to conform to the spirit and intent of this Plan.

### 6.2.1 Work Proposed Within the Public Right-Of-Way & Open Space Areas

- (a) **Maintenance or Minor Repairs** – routine maintenance or minor repairs to the surface of streets, sidewalks, or private accesses with the same material and the same dimensions
- (b) **Repair and Replacement of Underground Utilities or Services** – subsurface excavation for the repair and replacement of existing utilities (e.g. water, sewer, gas, electric, and telecommunications).
- (c) **Repair and Replacement of Above-Ground Utilities or Services** – repair and replacement of existing above-ground utilities (e.g. street lights, electric, and telecommunications) and associated works, including poles, conduits, and associated boxes or covers.
  - does not include the installation of new poles or light fixtures and new street furniture, including planters, tree grates, banners, hanging baskets, waste/recycling receptacles, and bike racks.
- (d) **Landscaping, Soft** – maintenance, installation, and replacement of any soft or vegetative landscaping confined to boulevard installations and associated planting beds.
  - does not include the installation of new trees or removal of trees with a height of 4.5m or greater or a diameter at breast height of 15cm or more.
- (e) **Landscaping, Hard** – removal or installation of hard landscaping, including private accesses, paths, and parking areas in the same materials and of the same surface area and dimension.
- (f) **Signs** – removal or installation of street signs in the existing design.

## 6.2.2 Work Proposed on Private Property

- (a) **Interior Alterations** – alterations to interiors of buildings or structures
- (b) Any alterations, additions, demolitions, and infill developments not visible from the street (or streets, in the case of corner lots and through lots)
  - does not apply if building has heritage designations at the municipal, provincial, or federal level.
- (c) **Maintenance or Minor Repairs** – routine maintenance or minor repairs to buildings, structures, and small paved areas that do not significantly affect the appearance of the outside of the property and do not involve the permanent removal of or damage to any character-defining element.
  - when visible from the street, does not include:
    - removing original cladding materials and replacing with other materials;
    - cleaning of any building façade surface (using cleaning methods such as chemical cleaning or pressurized water);
    - carrying out test patches in any location for any cleaning method;
    - removing paintwork from a masonry building façade surface.
- (d) **Roof Materials & Eavestroughs/Downspouts/Leads** – repairs to the existing roof or replacement of existing roof materials provided the basic form and composition of the roof is not altered, when visible from the street. Also includes removing existing and installing new eavestroughs, downspouts, or leads.
- (e) **Painting & Stripping Paint** – painting or stripping paint from trim, cladding, doors, window frames, eavestroughs, downspouts, or leads, and minor architectural elements.
  - when visible from the street, does not include
    - painting previously unpainted masonry elements; and
    - removing paint from a masonry building façade.
- (f) **Windows & Doors** – installing new doors and windows in the same locations and of the same size.
  - when visible from the street, does not include closing-in existing doors or windows, creating new door or window openings or increasing the size of existing door or window openings.
- (g) **Awnings** – replacing or installing new awnings.
  - when visible from the street, does not include installing new awnings or replacement awnings that are larger than the existing or that require additional building fastenings.
- (h) **Signs** – installing house numbers or non-illuminated signs up to 2 square feet in area that does not damage the heritage character of a building



- (h) **Landscaping, Soft** – installing, pruning, and maintaining soft or vegetative landscaping.
  - when visible from the street, does not include removing trees 4.5m in height or taller or with a diameter at breast height of 15cm or more.
- (i) **Landscaping, Hard** – removing hard landscaping, such as driveways, paths, decks, patios, and parking areas or installing in the same location.
  - when visible from the street, does not include installing any hard landscaping in new locations or expanding dimensions of existing hard landscaping.
- (j) **Fencing** – maintaining or installing fencing.
  - does not include installing new fencing in the front yard, when the fence exceeds 4 feet in height and when the solid-to-void ratio exceeds 30% solid.
- (k) **Accessibility Elements** – installing or expanding any accessibility elements (e.g. railings, ramps, lifts, paved areas) that do not involve the permanent removal of or damage to a character-defining element.
- (l) **Skylight, Solar Panels, & Satellite Dishes** – installing skylights, solar panels, satellite dishes and similar features that do not significantly affect the appearance of the outside of the property and do not involve the permanent removal of or damage to any character-defining element.
  - when visible from the street, does not include
    - skylights that depart from the roof pitch;
    - solar panels that depart from the roof pitch when roof-mounted, that are pole-mounted, or that require visible structural framework;
    - satellite dishes.
- (m) **Security Systems & Amenity Lighting** – installing security systems and lights, porch and other amenity lights, and seasonal lights.

### 6.2.3 Emergency Work

When emergency work is required to public or private property and circumstances dictate that heritage permit application and review are not possible due to imminent threats to persons or properties, such emergency work may proceed without a heritage permit. Notwithstanding the foregoing, all work must be undertaken in a manner that does not significantly affect the appearance of the outside of the property, involve the permanent removal of or damage to character-defining elements, or destroy valued heritage character.

## 7.0 Heritage Conservation District Policies and Guidelines

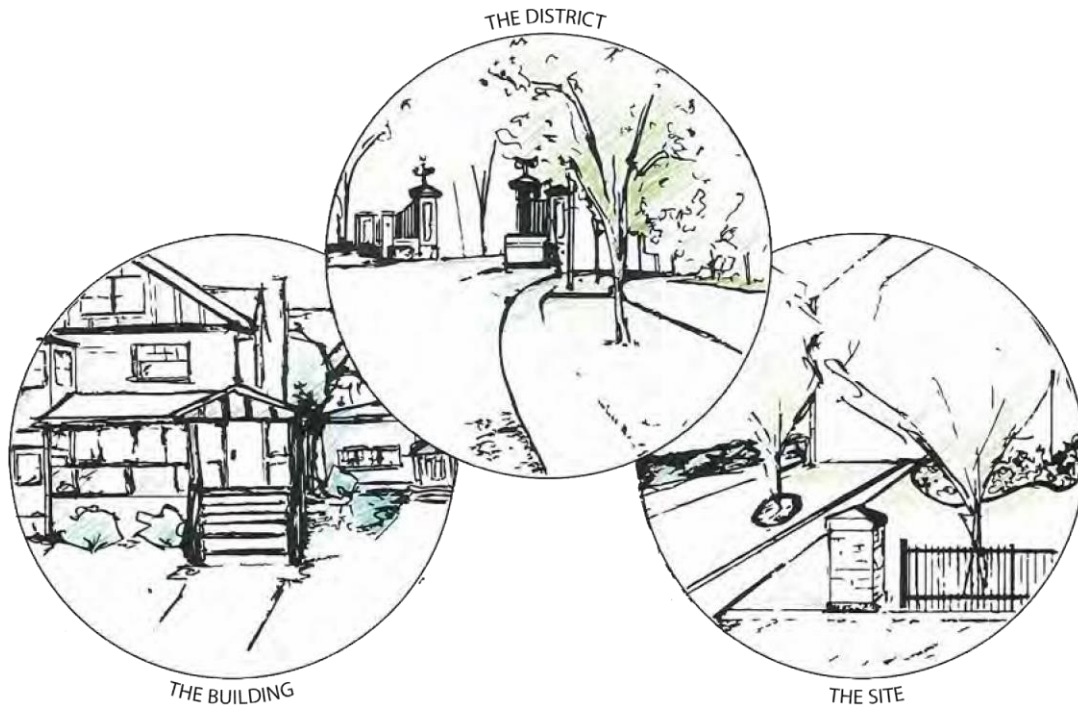

### 7.1 Intent & Format

The guidelines set forth in this section provide the framework for decision-making in the Armstrong's Point Heritage Conservation District. The policies set the direction for managing change within the district and are considered mandatory for all properties, whether privately- or publicly-owned. The guidelines set out ways and means to achieve policy direction in specific circumstances and have a key role in linking the Plan's policies with subsequent decisions concerning alterations to the district's heritage character.

The policies and guidelines are based on:

- (a) The Armstrong's Point Statement of Objectives;
- (b) The Armstrong's Point Statement of Significance; and
- (c) The "Parks Canada Standards & Guidelines for the Conservation of Historic Places in Canada".

Any alterations to the district and its resources are expected to respect and reinforce Armstrong's Point's history, its heritage value, and its character-defining elements. Changes to the overall district or to its individual resources that destroy, damage, diminish, or detract from the district's heritage values and character-defining elements are not permitted.

## 7.2 The District Policies

The District-related policies are either district-wide in scope or specific to its key organizing features (e.g. lot pattern, streets, sidewalks, boulevards, parks & open spaces). In terms of HCD Plan objectives for The District section, most prominent are Armstrong's Point District-wide objectives and public realm / street right-of-way objectives which are detailed in the Statement of Significance.



*West Blanchard Park*

### 7.2.1 Lot Pattern

- (a) Retain the established district lot pattern, with each lot fronting on a public street and having vehicular access directly to the street.
- (b) Consider subdivisions and/or consolidations of existing lots where there is historic evidence of proposed dimensions(e.g. lots of record, obsolete subdivisions, or cases where a through lot is subdivided in order that each resulting lot has street frontage).
- (c) Alternative lot layouts, such as “auto courts”, “loop lanes”, and “flag lots” will not be supported.

## 7.2.2 Principal Building Setback to Street

- (a) Retain the generous district (front yard significantly deeper than 20ft) setback between the front wall of principal buildings and the public street right-of-way characteristic of the district.
- (b) Locate additions to existing principal buildings in the rear or side yard, with side yard additions recessed from the front wall.
- (c) Ensure new buildings maintain previous front setback on the property; in cases where the previous building's setback differed significantly from those of immediately neighbouring properties, the new principal building may be aligned with the setback established by these properties.

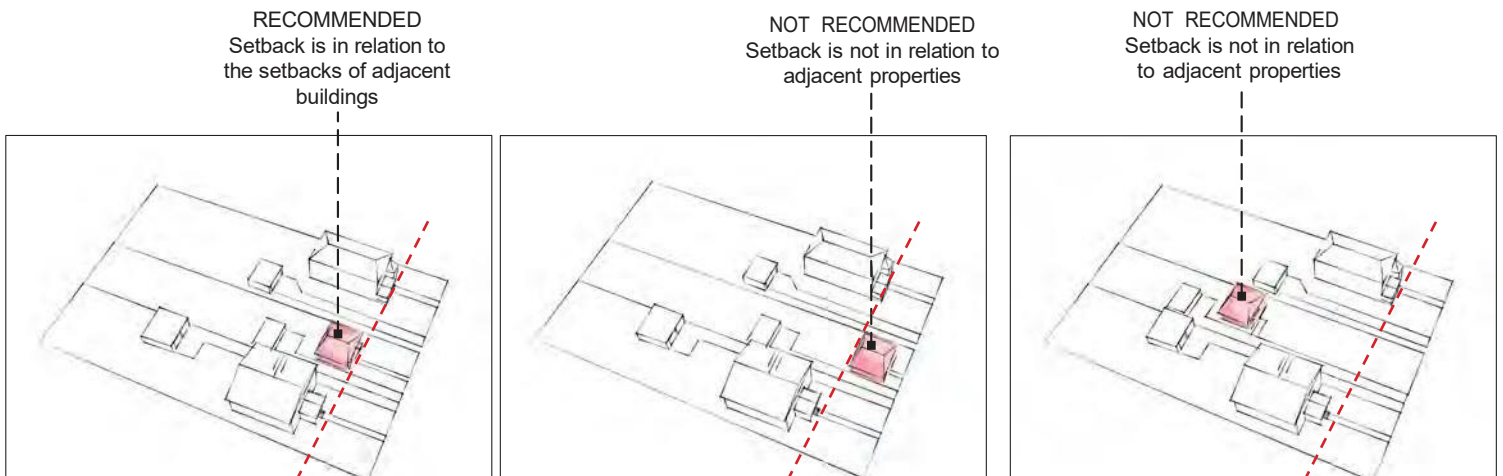

## 7.2.3. Open Spaces

- (a) Retain existing public open spaces within the district (e.g. East Blanchard, Middle Gate, West Blanchard street ends, Cornish Library grounds), including existing mature trees and vegetation.
- (b) Maintain public access to the Assiniboine River.
- (c) Ensure safety through selective thinning of ground-oriented foliage that improves views into and out of the open space.
- (d) Accommodate vehicular driveways on public land only where direct access to the fronting street is not available or is not viable; in these cases, locate in position that reduces conflict with pedestrians and open space users.
- (e) Maintain naturalized and riparian vegetation, including through removal of invasive species.



## 7.2.4 Views

- (a) Retain views to the river at existing open spaces.
- (b) Retain views to and from the district through the ornamental gate features at the Cornish Avenue intersections with East Gate, Middle Gate, and West Gate.
- (c) Within the district, retain views in both directions along each street as defined by the regular placement of deciduous trees in the boulevards.
- (d) Maintain existing boulevard trees that frame views along the streets, as well as inter-planting where gaps in tree spacing are evident.
- (e) Provide ongoing maintenance of and repair to the ornamental gate features.
- (f) Locate and design new above-ground utilities in order to respect valued views.

## 7.2.5 Streets

- (a) Retain the existing street system, including street cross-section dimensions, surfacing, and curbing.
- (b) Accommodate street modifications (e.g. intersection bump-outs at crosswalks) where doing so contributes to pedestrian safety or accessibility.
- (c) Ensure street ends that terminate at the river [i.e. Blanchard, Middle Gate] remain in public ownership and enable access to and from the river.

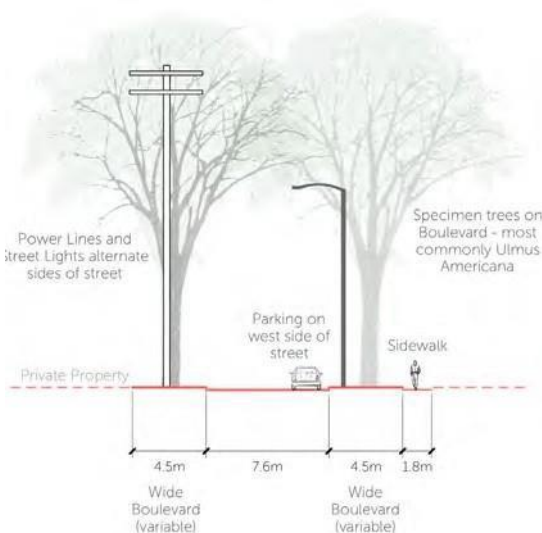

*Typical East Gate & West Gate Street Section*

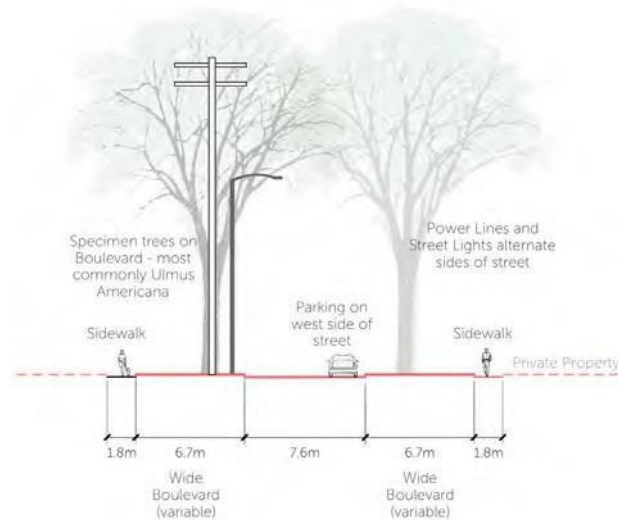

*Typical Middle Gate Street Section*



## 7.2.6 Sidewalks

- (a) Retain existing public sidewalks, including cross-section dimensions and surfacing.
- (b) Accommodate existing and future cut-outs for boulevard trees.
- (c) Accommodate sidewalk widening and surfacing modifications where doing so contributes to pedestrian safety and accessibility.
- (d) Accommodate new sidewalks where increased pedestrian traffic warrants.

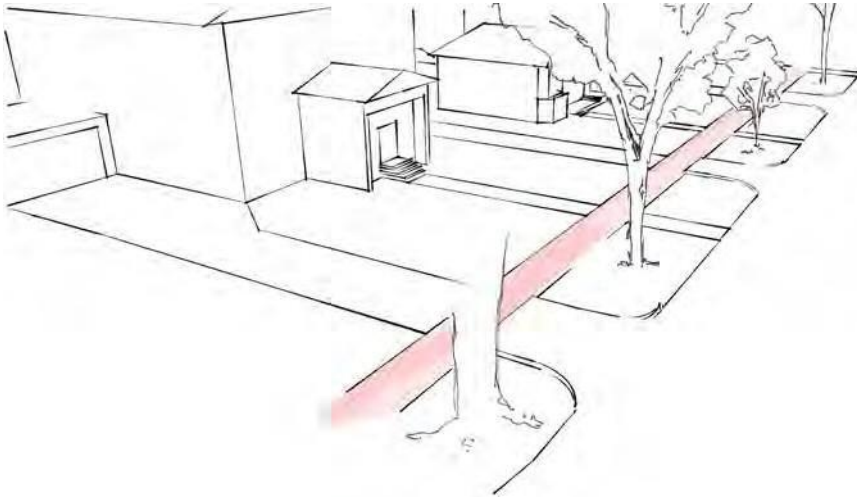

## 7.2.7 Boulevards

- (a) Retain existing soft landscaping within the public boulevard (i.e. public street right-of-way from curb to public sidewalk), including boulevard trees, pre-settlement trees, and grass.
- (b) Accommodate alternative soft landscaping treatments (e.g. native plant materials, perennial flowers, ornamental grasses).

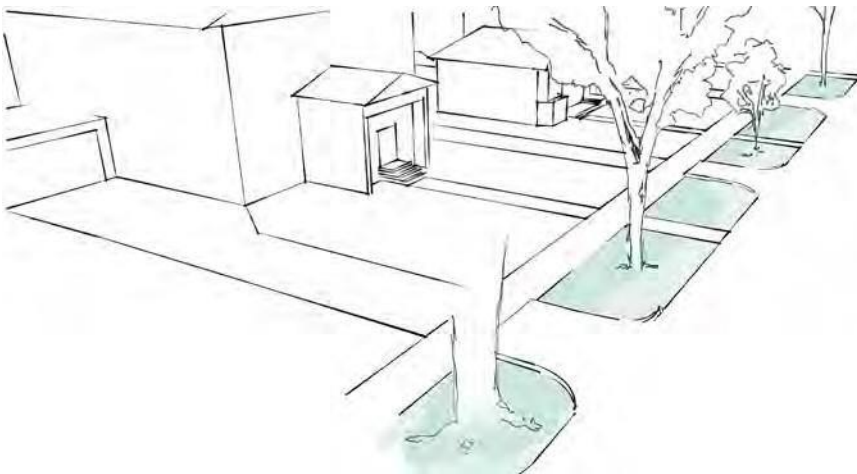

- (c) Encourage efforts to maintain existing boulevard trees through regular pruning and other initiatives;
- (d) Encourage inter-planting of new boulevard trees, in coordination with The City of Winnipeg, The Armstrong's Point HCD Advisory Committee, and the Armstrong's Point Association, where continuity gaps are evident;
- (e) Minimize hard surfacing associated with utilities and services (e.g. community mailboxes, utility boxes, recycling/waste receptacles, transit stops).

#### 7.2.8 Private Approaches

- (a) Retain modest vehicle access to private properties, including predominantly single vehicle width private accesses with all-weather surfacing.
- (b) Double vehicle width private accesses, including through accommodating second access points where property width or flankage allows are not permitted.
- (c) Locate new private accesses in a manner that protects boulevard and pre-settlement trees.

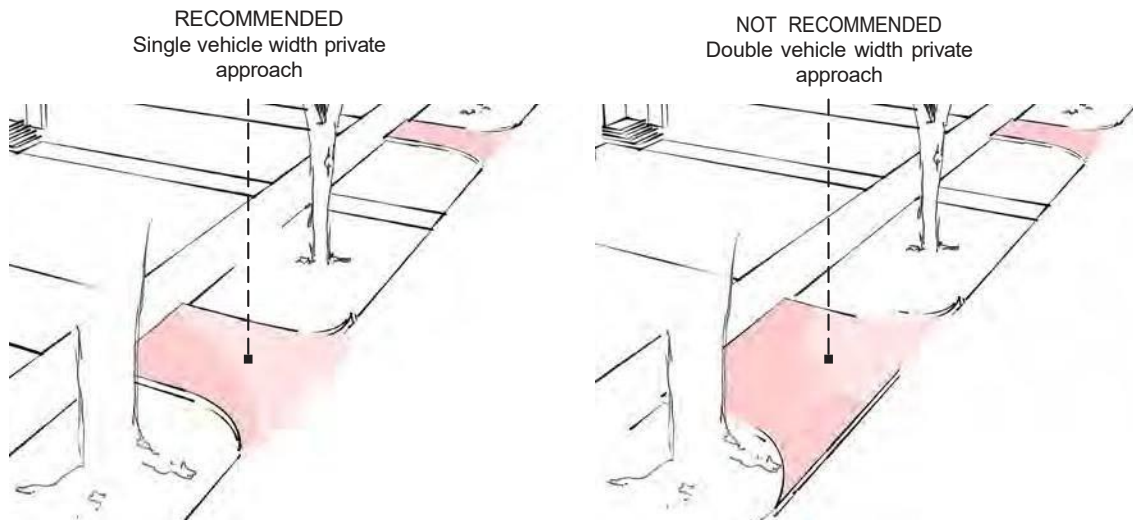

#### 7.2.9 Utilities

- (a) Accommodate new streetlight poles and light fixtures where safety concerns warrant.
- (b) Introduce alternatives to existing streetlight poles only as an outcome of thorough research of styles previously used in the district.



*The Cornish Gates offer an iconic entrance into the District.*



*This pre-settlement cottonwood, located in the riparian forest at the south end of Middle Gate, stands as a key example of old growth trees in the District.*



*This typical streetscape alignment demonstrates the District's wide boulevards, subordinate private approaches and large overarching tree canopy.*



*East Blanchard Park, a designated park space in the District, retains beautiful views and access to the river.*



## 7.3 The Site Policies



The site-related policies are specific to individual public and private properties. These policies relate to matters such as building situation and orientation, gardens and vegetation, fences, driveways and parking areas, pathways, and accessibility elements, but do not include building design or details.

### 7.3.1 Principal Building Footprint

- (a) Retain a building footprint-to-lot area ratio that is characteristic of the district; lot coverage shall be compatible with abutting properties.

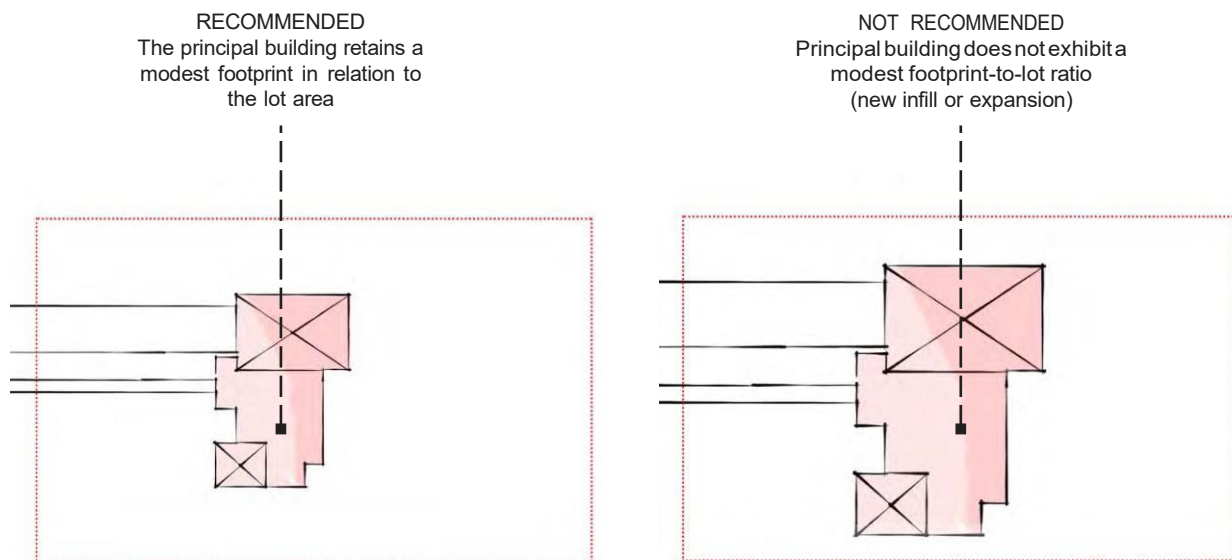

- (b) Locate new principal buildings with consideration for existing mature vegetation, natural landscape, and topographic features.
- (c) Locate new principal buildings in order to sustain the consistent rhythm of buildings-to-open spaces along the street.

### 7.3.2 Views to Principal Buildings from the Street

- (a) Retain the characteristic unobstructed view of principal buildings from the street.
- (b) Protect and maintain existing fences, fence-posts, gate-posts, and other historic property delineation markers.
- (c) Accommodate new front yard fences, garden walls, and hedges that allow a clear or filtered view of the principal building through height and composition limitations.

RECOMMENDED  
Maintain characteristic hedge screen / garden wall

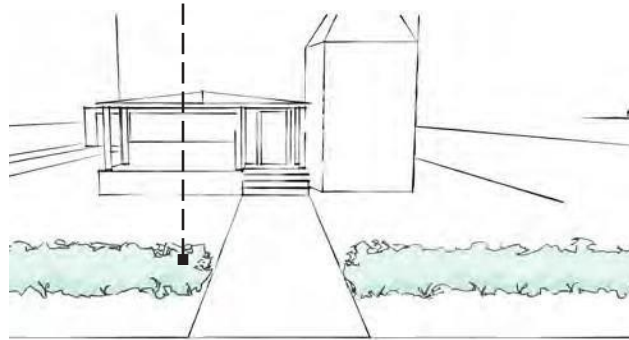

RECOMMENDED  
Maintain historic decorative fence and features

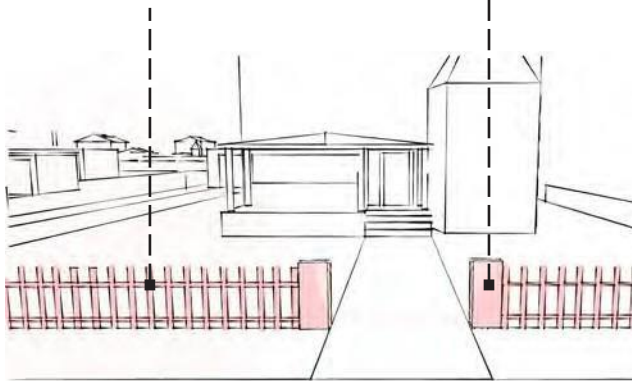

RECOMMENDED  
Maintain historic columns

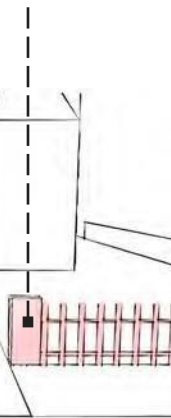

NOT RECOMMENDED  
Solid fencing obscures view of principal building from street

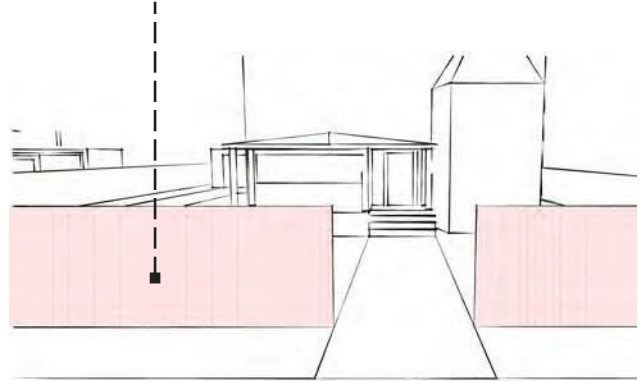



### 7.3.3 Siting of Accessory Buildings

- (a) Retain the subordinate status of accessory buildings by minimizing their visibility from the street.
- (b) Locate detached garages, sheds, and other enclosed accessory buildings either in the rear yard or in the side yard, with those in side yards set back from the principal building front wall;
- (c) Gazebos and other temporary shelters may be accommodated in the front yard, provided views of the principal building from the street are not significantly compromised.

### 7.3.4 Front Yard Landscape, Soft

- (a) Retain the characteristic prominence of soft landscaping in the front yard, including lawns, planting beds, trees, and gardens.
- (b) Minimize reductions to the large expanses of soft landscaping in the front yard and in areas visible from the street.
- (c) Protect and maintain the existing tree canopy and encourage new plantings.

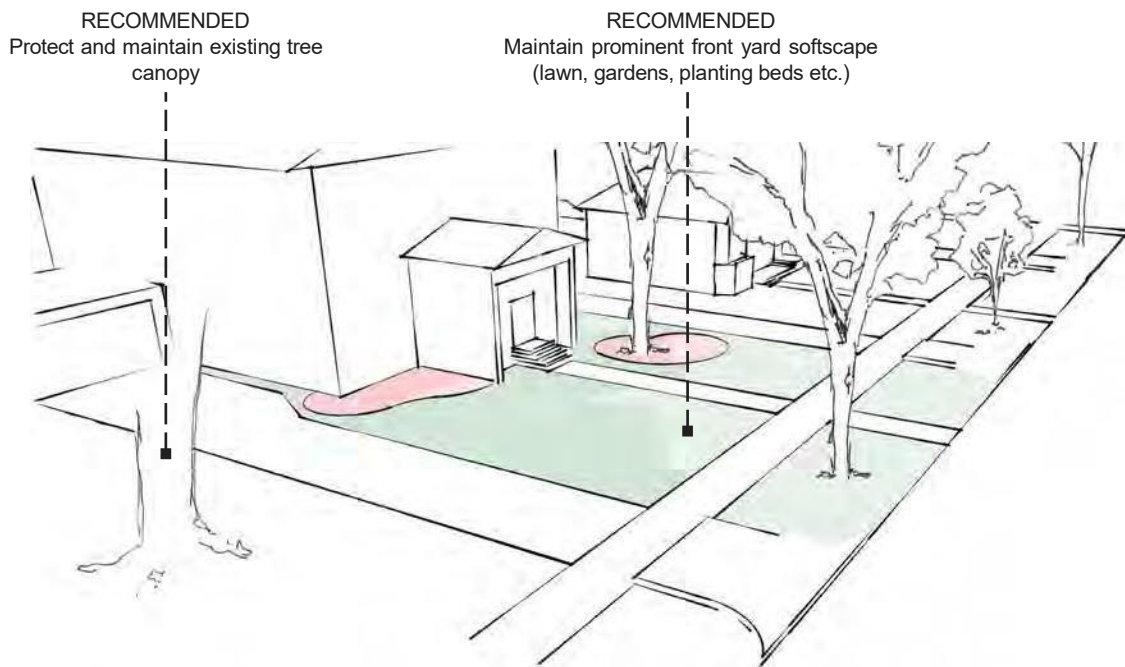

### 7.3.5 Front Yard Landscape, Hard

- (a) Retain the modest scale and dimensions of hard landscaping, including driveways, parking areas, foot paths, statuary, and patios, in the front yard.
- (b) Restrict driveways to single vehicle width.
- (c) Allow circular (i.e. semi-circular) driveways where lot width accommodates, as an alternative to double-wide driveways.
- (d) Locate parked vehicles to the rear or side of the principal building; restrict parking in front of the principal building to the driveway.
- (e) Encourage low-impact, permeable driveway surfacing as an alternative to asphalt, concrete, pavers, and compacted gravel.
- (f) Accommodate statuary and other vertical features in the front yard, provided views to the principal building from the street are not significantly compromised.

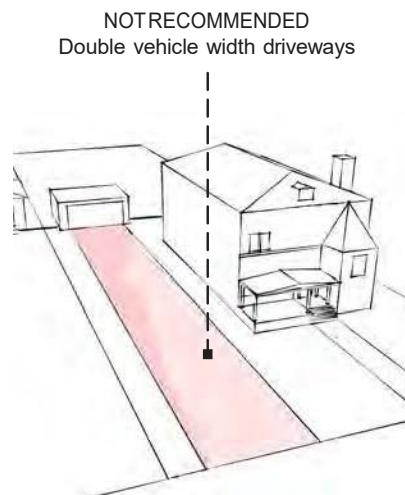
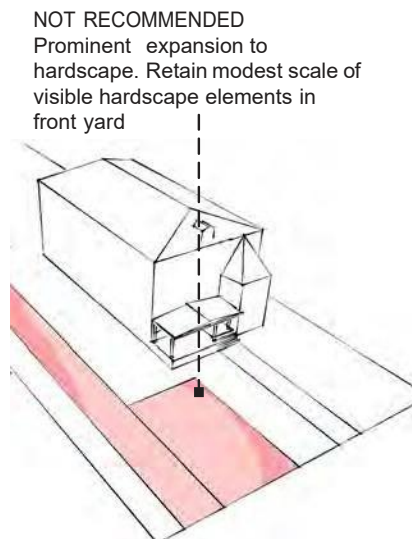
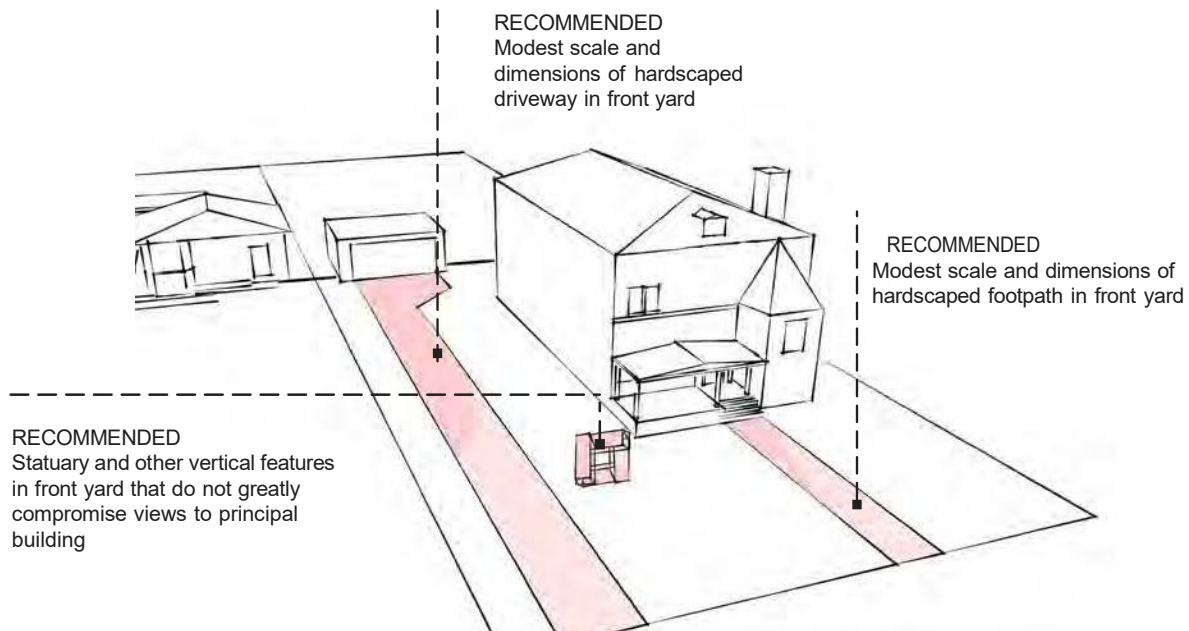

### 7.3.6 Utilities, Sustainability, & Accessibility

- (a) Ensure utilities, sustainability elements (e.g. solar panels), and accessibility elements are visually and physically compatible with the existing building.
- (b) Locate utility infrastructure, service connections, sustainability elements, and solid waste storage areas in rear or side yard locations; where not viable, screen with hedging, low garden walls, or similar measure.
- (c) Accommodate accessibility elements as required and ensure these are designed to minimize alteration to the principal building.



*This front yard demonstrates a balance between soft and hard landscaping. It has a single lane driveway, and the vertical features do not obstruct views of the Principal Building.*



*A historic decorative fencing property delineation marker with a characteristic masonry column.*



*A characteristic hedge delineates a property line. Hedges like these are a recurring feature throughout the District.*



*This prominent front yard landscaping balances a modest single lane driveway.*





*This English style garden is a prominent, eye-catching feature of the front landscape.*



*The scale of this front yard private walkway is modest in relation to the prominent softscape.*



*Succession planting with species diversity helps to remediate losses due to Dutch elm disease and declining health of mature shade trees.*



*Mature, pre-settlement elm and oak trees are a characteristic feature of the District. Succession planting is recommended to replace trees lost to disease.*



## 7.4 The Building Policies



The building-related policies are specific to building design and details (e.g. alterations and additions to existing buildings, accessory buildings, new infill developments, demolitions).

### 7.4.1 Principal Building Alterations

#### (a) General

- (i) Ensure alterations to existing buildings are physically and visually compatible with the existing building and that alterations minimize damage to or loss of heritage character, when visible from the street.
- (ii) Protect and maintain original architectural features of the front wall (and side wall, where side wall also flanks street), including cladding materials, exposed structural elements, and decorative features.
- (iii) Maintain original architectural features, including repair using original materials where possible.
- (iv) Repair original architectural features, rather than replacing.
- (v) Replace original architectural features only where materials have deteriorated to the point where repair is not viable; in these cases, replace deteriorated materials in kind, including proportions, patterns, stability, and durability.

#### (b) Entrances

- (i) Protect and maintain the original location, orientation, and dimensions of entrances, including doors, door surrounds, materials, glazing, stairways, and lights.
- (ii) Locate new entrances along secondary walls (e.g. rear or side); where other options are not viable, design additional entrances to be compatible with the symmetry of the front wall and secondary in proportions and details to the original entrance, when visible from the street.

**(c) Roofs**

- (i) Protect and maintain original roof symmetry and features, such as chimneys, eaves, dormers, and others where these features are characteristic of the principal building's architectural style.
- (ii) Retain original chimneys when no longer required for building services, when visible from the street.
- (iii) Locate rooftop equipment at positions not visible from the street, unless original to the building.
- (iv) Locate skylights at positions not visible from the street; when not viable, design to be low-profile and consistent with the roof line.

**(d) Windows**

- (i) Protect and maintain the original location, orientation, and dimensions of window openings, including surrounds, brick moulds, materials, framing, hardware, and other features where these features are characteristic of the principal building's architectural style.
- (ii) Accommodate new window openings provided that doing so is visually and physically compatible with the existing building. when visible from the street.
- (iii) Avoid blocking-in of original windows, when visible from the street.
- (iv) Accommodate new shutters and other forms of window ornamentation when they are characteristic of the principal building's architectural style.

**(e) Porches & Verandas**

- (i) Protect and maintain original porches and verandas, including materials, posts, railings, brackets, stairways, lights, and roofs.
- (ii) Restore porches and verandas, and recreate missing elements of these based on evidence.
- (iii) Accommodate closing-in of porches and verandas as all-season conditioned spaces providing doing so maintains original look, features, and work is reversible, when visible from the street.

## 7.4.2 Principal Building Additions & Accessory Buildings

### (a) General

- (i) Ensure additions are subordinate to and distinguishable from the existing principal building, but still compatible with it through careful consideration of height, massing, materials, door & window patterns, and rooflines.
- (ii) Retain heritage character of the existing building.
- (iii) Locate additions at the rear or side of the original building.
- (iv) Recess the addition front wall back from the front wall of the original building, when visible from the street.
- (v) Accommodate vertical additions up to a maximum building up to a 3rd-storey height, provided that doing so is visually and physically compatible with the existing building, when visible from the street.
- (vi) Locate additions to existing buildings or accessory buildings with consideration for existing mature vegetation, natural landscape, and topographic features.

RECOMMENDED  
New addition is subordinate to principal building

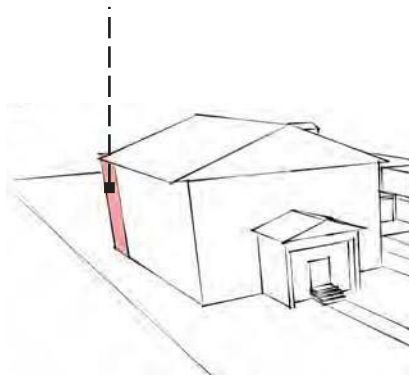

RECOMMENDED  
New addition is subordinate to principal building

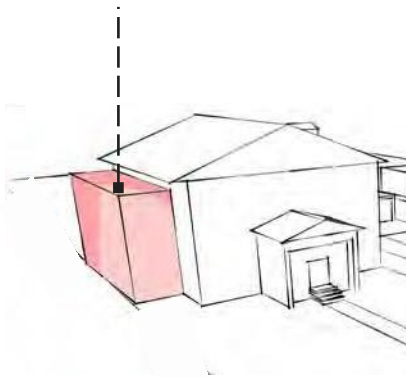

NOT RECOMMENDED  
New addition is not subordinate to principal building

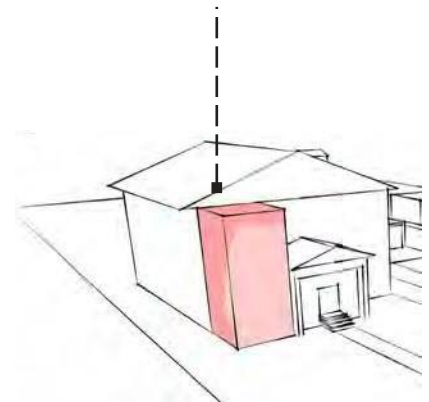

### (b) Entrances

- (i) Ensure new entrances in additions are subordinate to the primary principal building entrance, in terms of location, dimensions, and design.
- (ii) Design entrances to the addition to be compatible with the symmetry of the front wall and secondary in proportions and details to the original entrance, when visible from the street.

### (c) Roofs

- (i) Ensure the roof form of an addition is visually and physically compatible with the existing building.
- (ii) Locate rooftop equipment at positions not visible from the street.

**(d) Windows visible from the street**

- (i) Ensure the addition's windows are visually and physically compatible with the existing building, in terms of alignment, design, and dimensions.
- (ii) Design addition windows that are visually and physically compatible with the existing building.

**(e) Porches & Verandas**

- (i) Accommodate porch and veranda additions that reflect the style of the existing building and are physically and visually compatible in terms of location, orientation, scale, design, and materials—including posts, railings, brackets, stairways, lights, and roofs.
- (ii) Introduce new porches and verandas only where they are characteristic of the principal building's architectural style and are visually and physically compatible with the existing building.

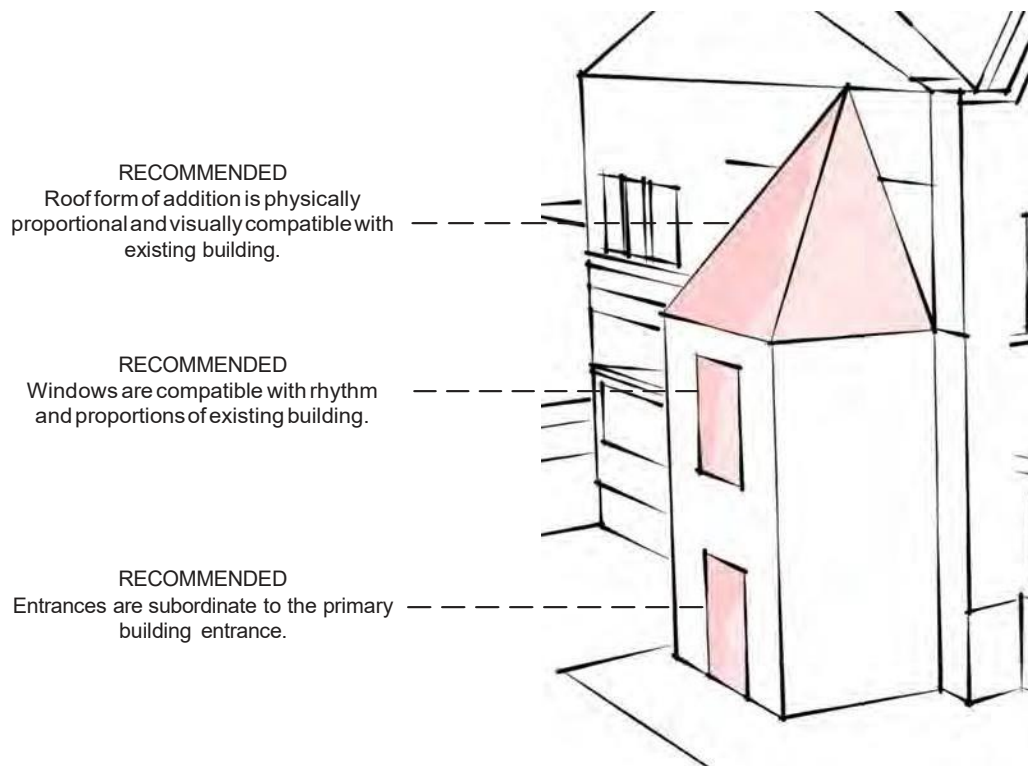



**(f) Attached Garages visible from the street**

- (i) Accommodate attached garage, porte cochere, and carport additions that are subordinate to the existing building in terms of location, dimensions, and design.
- (ii) Design garage, porte cochere, and carport additions to be visually and physically compatible with the principal building.

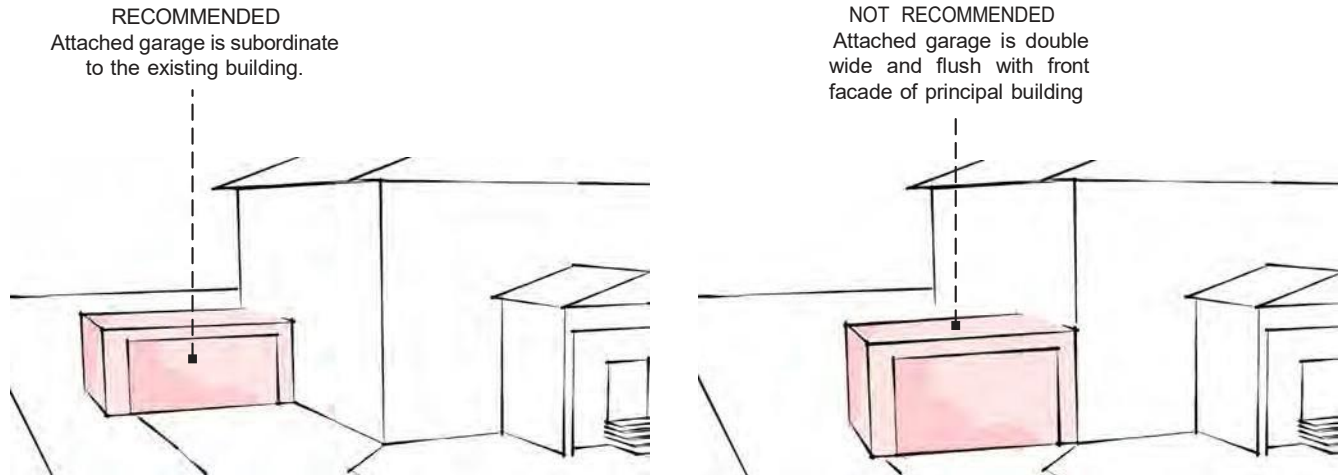

**(g) Accessory Buildings**

- (i) Ensure exterior walls of new accessory buildings are compatible with the principal building, in terms of materials, finishes, and detailing, when the accessory building is visible from the street.

### 7.4.3 New Infill Developments

#### (a) General

- (i) Ensure new infill development is compatible with the existing streetscape, in terms of setback, spacing, mass, rhythm, and orientation.
- (ii) Encourage new infill development to be a product of its time, but also respectful of and sympathetic to the district.
- (iii) Encourage cladding materials of new infill development to be compatible with colours and materials characteristic of the district, when visible from the street.
- (iv) Accommodate new principal buildings ranging in height from 1-storey to 3-storeys.

#### (b) Entrances

- (i) Ensure the primary entrance to new infill development is visible from and oriented towards the street.

#### (c) Roofs

- (i) Encourage roof forms, materials, and rooftop equipment to be compatible with those characteristic of the district, when visible from the street.

#### (d) Windows

- (i) Ensure windows in new infill developments are respectful of and sympathetic to the character and scale of the district.

#### (e) Porches & Verandas

- (ii) Accommodate porches and verandas as components of new infill developments, provided they are appropriate for the style of the new building and are compatible with the characteristics of the district, when visible from the street.

#### (f) Garages visible from the street

- (i) Accommodate garages as components of new infill developments, provided they are incorporated into the new building's proportions, rhythm, and massing when integrated into the front wall or subordinate to the new building, when otherwise visible from the street.
- (ii) Design garage, porte cochere, and carport components to be visually and physically compatible with the new principal building.

**(g) Accessory Buildings**

- (i) Accommodate accessory buildings that are subordinate to the new principal building, when visible from the street.

**7.4.4 Demolitions**

As with alterations, efforts to maintain and repair principal and accessory buildings are expected to be undertaken prior to any consideration of potential demolition or relocation. Where maintenance and repair efforts are not viable (e.g. due to extent of damage from a fire or natural disaster), demolition and/or relocation may be considered under the Heritage Permit review process.



*This home features a front door surround and a distinctive roof shape and form.*



*These decorative dentils and distinctive roof brackets are characteristic architectural features, and the wood shingle cladding is characteristic of District.*



*A distinctive roof form and dormer window, with prominent sills and a red masonry facade.*



*A property demonstrating a porte cochere.*





*Decorative chimneys should be maintained as a distinctive character element of the District.*



*Maintain roof form and distinctive window surrounds.*



*Maintain key architectural features, such as decorative cladding and facade details. Maintain distinctive window surrounds and Dormers.*



*Maintain detailed door surrounds and transom windows.*

## 8.0 Armstrong’s Point HCD Advisory Committee Terms of Reference

### 8.1 INTERPRETATION

In this document:

“**Advisory Committee**” means the Armstrong’s Point Heritage Conservation District Advisory Committee;

“**Council**” means the council of The City of Winnipeg;

### 8.2 AUTHORITY

Formation and activities of the Advisory Committee is authorized pursuant to the HCD By-law, and is formalized through the adoption of an HCD plan for Armstrong’s Point.

### 8.3 FUNCTION

The Advisory Committee shall, on an as-needed basis:

- (a) provide advice to the public service on issues specific to the Armstrong’s Point HCD as well as HCDs generally; and
- (b) review applications for heritage permits on an as-needed basis.

### 8.4 MEETINGS

The Advisory Committee shall meet as needed.

### 8.5 DUTIES AND RESPONSIBILITIES

The Advisory Committee’s responsibilities are as follows:

- (a) review and offer advisory input into process, policy and programs regarding the Armstrong’s Point HCD on an as-needed basis;
- (b) make recommendations concerning development applications with respect to the HCD Plan;
- (c) evaluate heritage permit applications on an as-needed basis and give advice to the Designated Employee as to whether the said applications complies with the guidelines outlined in the HCD Plan; and
- (d) provide updates on Advisory Committee activities and workload as needed.

Advisory Committee members are expected to attend meetings regularly, be punctual, and be prepared.

## **8.6 CRITERIA FOR MEMBERSHIP**

The Advisory Committee membership shall not be less than three (3) members of the Historical Buildings and Resources Committee (HBRC), who will participate on a voluntary basis.

As Advisory Committee members participate on a voluntary basis, there shall be no term lengths.

## **8.7 VOTING**

Voting is by majority rule.

## **8.7 SUPPORT**

Staff from Winnipeg's Urban Planning and Design Division will be assigned as needed to support the Advisory Committee.

The Director of the City of Winnipeg's Planning, Property and Development Department must provide professional and technical support to the Advisory Committee sufficient for the Advisory Committee to perform its function.

The Advisory Committee may request input from others as needed.

## 9.0 Community Consultation Results

Community engagement opportunities to provide input into the HCD study and HCD plan commenced in 2015 and continued through to 2017. A variety of methods were utilized—including information sessions, workshops, and open houses—to involve community members in the study and plan preparation. Community engagement during the plan preparation phase was intended to:

- update and review the findings of the Heritage Conservation District Study;
- provide a baseline understanding of what an HCD Plan is, what it may include, and its relationship to the HCD Study;
- advise community members on the plan preparation process;
- provide opportunities for community member input into the HCD Plan; and
- review draft Policies and Guidelines.

The Armstrong's Point Association (APA) is a non-profit area resident's organization formed over fifty years ago. The APA was instrumental in notifying area residents of upcoming community engagement sessions. To gain input into the development of the HCD plan, the project team held a facilitated public information meeting and an evening workshop. Both events were well attended by area residents.

The consultant team also attended a public home tour event organized by the APA, at which the team provided the broader public with information on HCD planning. Armstrong's Point residents were invited to contribute to the HCD plan both in-person and through an online survey on the City of Winnipeg's project website. A community-led meeting was also held at the public library to further discuss the draft plan. The Armstrong's Point HCD study includes additional consultation results.

In April 2017 an open house was held in Armstrong's Point to share the draft HCD Plan with the community and to receive feedback. City of Winnipeg staff and consultant team members were available to discuss plan details. There was strong in-person and online support for the HCD Plan and its component parts.



*October 15th, 2015  
Community Workshop*



*September 11, 2016  
Heritage Home Tour  
Information Display*



*November 9th,  
2016 Community  
Workshop*

The following pages summarize public engagement related to the HCD study and HCD plan.

PUBLICENGAGEMENT SUMMARY (HCD Plan 2016-2017)			
PUBLICENGAGEMENT	DATE&VENUE	PARTICIPATION	DELIVERABLE
Public Information Meeting (HCD Plan content & direction)	St. Mary's Academy June 22, 2016	22 participants	Presentation, question and answer session. 'What We Heard' report
On-Line Survey#1 (HCD Plan content & direction)	June 22, 2016 - November 17, 2016	44 respondents	Survey response summary
Armstrong's Point Heritage Neighbourhood Tour	September 11, 2016	100+ tour participants	Public Display - presentation boards, consultant team in attendance
Project Bulletin Update	October 27, 2016	Home delivery 129 residences	Update on HCD Plan development & website
Public Workshop (draft Policies & Guidelines)	Universalist Unitarian Church November 9, 2016	28 participants	Presentation, facilitated table discussions, Summary of Findings report
On-Line Survey#2 (draft Plan Policies & Guidelines)	November 9, 2016 – January 31, 2017	9 respondents	Survey response summary
Open House	University Women's Club April 19, 2017	±30 participants	Presentation Boards
Open House Feedback Form	April 19, 2017	7 respondents	Feedback comment summary

Public meetings and open house events were promoted in the following ways:

- direct home mail delivery (129 residences);
- stakeholder email list (61 email addresses);
- Armstrong's Point Association members' social media;
- posters (Cornish Library, BIZ public notice boards).

Additional presentations and summaries of feedback received at the public information meeting and the public workshop is available on the City of Winnipeg website: [www.winnipeg.ca/heritagedistricts](http://www.winnipeg.ca/heritagedistricts)



## Public Workshop - June 22, 2016 Armstrong's Point HCD Study and Plan



The following feedback was provided by workshop participants to the question: "What would you like to see in the HCD Plan for Armstrong's Point?".

Comments were recorded by facilitators at small conversation table groups. The meeting concluded with participants sharing highlights of their findings with the large group.

### General HCD concerns and comments

- Ensure decisions consider environmental costs and concerns i.e. tree decline and succession, storm water and run-off, energy efficient buildings
- How to manage properties that fall into disrepair? Recommendations / regulations are to encourage on-going property maintenance (so buildings do not fall into disrepair and require removal)
- Flexibility!
- Flexibility to reflect different types of built resources
- Is there a mechanism for placing interim hold on development permits until an HCD Plan is in place?
- General large group discussion on nature of the process for items that require approval, e.g. resident representation or independent approval body or some combination thereof.

### Approvals and Permit Process

- Rigour of review approvals – need to reflect the Plan intention
- Mechanism for City of Winnipeg internal planning department to run concurrently with HCD review process
- Simplify the permit and approval process
- Simplify the permit process when it comes to re-establishing historic character and features
- Should be an unbiased expert group – separate from neighbourhood
- Association – is it representative? Should be residents (like jury duty) to serve on the committee – rotation/appointments – Citizen input is important for rebuilds or major changes to façade
- Hybrid approach to incorporate both a community advisory review process and an external expert group review (within the City)

### Financial Support/Considerations

- Support or incentives (i.e. taxes) for maintaining heritage character

- Cost—how can people recover the cost/investment of re-installing/restoring heritage fabric (i.e. cladding)
- How can restoration be more accessible financially?
- Considerations:
- Converting buildings into condominiums only if the heritage value is protected – perhaps restrictions on number allowed in district
- Tax-incentives
- Cost forgiveness on restoration / renovation
- Tax incentives
- Cost Matching? Grants?
- Consider the extreme costs of bringing heritage buildings fully up to the provincial energy code – “all or nothing” mentality

### **Zoning/Existing by-laws and policies**

- Residential use / form of buildings
- R1 Status – how will it work with the HCD Plan
- How to manage historical accuracy vs provincial codes (ex. restoring historic fabric that is no longer to code – such as low railings)

### **Demolitions/Subdivision**

- Restrict demolitions and Lot subdivision
- If demolition is permitted – consider a building tax on new constructions and the period of time the lot would remain vacant (to discourage vacant lots for long periods of time)
- Demolition limitations

### **Renovations / Restoration / New builds**

- Give and take is needed for guidelines. Find good solutions i.e. matching of windows in new materials but in keeping with the character
- Preserve character of district in new builds and existing building renovations
- Advice on windows
- Energy efficiency to be accommodated (solar panels)
- Chimneys
- Character of new designs
- Size of new additions / dwellings
- Address adaptive re-use/ adding new units – incentives
- Should new builds / additions be made to reflect/replicate the historical period to “blend” with the heritage district, or should they be made to be contemporary (subordinate, new, but reflective of overall district character)?
- Concerns over loss of heritage homes and new builds being excessive, large and imposing (ex. Wellington Crescent)

### **SiteLayout**

- Maintaining layout set-backs
- Lot layout / set-backs – as long as the character is maintained, open to front additions etc.
- Importance of front yard setbacks

### **Parking/Paving**

- Restrict in front yard of properties – reinforce existing by-law
- Keep garages recessed in back
- Restrict street parking during the day – recommend 1hr max from 9am – 5pm
- Issue permits (ie \$25 parking pass) to residents who want additional parking and construction crews etc.

### **Materials/Colours**

- New materials – some are not appropriate materials in keeping with heritage character. Need for new material guidelines
- No colour restrictions – but recommendations for appropriate colours and period
- Painting brick – not encouraged

### **Landscaping/ Trees**

- Tree protection and replacement – not only boulevard trees but in trees in rear yards should be considered as well
- Consider working with hydro especially around pruning and siting of new trees. Need City's help through HCD to get them on board about special requirements on these matters in an HCD.
- Context of environmental protection of trees is not just in public realm – how can we ensure the entire district tree canopy retention – because the sum is greater than the parts. Guidelines for replanting when one is taken out.
- Landscaping – should be fairly flexible, in front yards but not to distract from long vistas and viewshed. Do not encourage gardening on boulevard
- Protect trees and riverbank
- Tree protection & tree collection renewal - removal of hazard trees
- Guidance desired for fencing and hedging

### **Streetscaping/Approaches**

- Street alignment maintained
- Retain existing street profile
- Guidelines for approaches (outside the district)
- Retain boulevards

## June 22, 2016 Public Workshop Questionnaire results



1. What guidelines, issues or topics would you like to see included in a Heritage Conservation District Plan for Armstrong's Point?  
- Respondents cited multiple issues and topics which framed the creation of the HCD plan.
2. What do you hope will be achieved with a Heritage Conservation District Plan for Armstrong's Point?  
- 41 respondents spoke positively, mostly citing hopes to preserve residential character and acknowledge the historic significance of the neighbourhood. One respondent stated their hopes that this plan not go forward.
3. How informed do you feel about the Armstrong's Point HCD Study and Plan? (44 responses)
  - a. Well informed - 34%
  - b. Adequately informed – 45%
  - c. Not as informed as I'd like to be - 22%
4. Do you live in Armstrong's Point? (44 responses)
  - a. Yes – 93%
  - b. No – 7%
5. Do you own property in Armstrong's Point? (43 responses)
  - a. Yes – 91%
  - b. No – 9%
6. Please share with us any concerns you have about the project:
  - Encouraging homeowners to upgrade homes
  - Decreasing government controls
  - Process concerns (too slow, not thorough enough, etc.)
  - Encroachment of institutions in the area
  - Recent infill housing
  - Maintaining protection for infill homes, having a plan with 'teeth', not allowing variances
  - House maintenance
  - Street parking
  - Worries that one type of architecture would be imposed on all houses
  - Delays and costs associated with making changes

Please Note: this is a summary of comments received from workshop attendees at the November 9th HCD Plan workshop. Participants were provided copies of the DRAFT HCD Policies and Guidelines and asked to provide comment. The following has not been edited or organized in any specific manner, and as such represents the variety of opinions and approaches on the proposed HCD Policies and Guidelines.

### General HCD concerns and comments

- Change has occurred over the years, and can be for the better - thoughtful change in moving forward is needed;
- Term “Character neighbourhood” vs “Heritage neighbourhood” – possibly more representative of the building diversity;
- Incremental back sliding – institutions may purchase homes slowly over time;
- Fear of becoming areas like Roslyn or Wellington without guidance;
- Accommodate thoughtful deviation from patterns and guidelines based on variation in the district;
- If compliance does not require a permit, why have guidelines?
- Find balance between “evolution and infill” and “conservation/preservation of heritage character”;
- The setting and landscape are more significant to district character than architectural details.

### Process and Implementation

- No “design police” – preference for neighbourhood committee to discuss big ticket items;
- Concerns over staff regulation at the City of Winnipeg – how could they possibly police every tree removal?
- If too onerous, people are likely to forgo permit process altogether – streamline the process;
- Consider instances when alterations are done without knowledge, or Adherence to the guidelines. Will there be repercussions for those who do not conform to Plan?
- Heritage premium – original look can cost more;
- Revenue for income for larger homes – don’t want to see homes broken up into tenements; OR
- Consider “smart” divisions where the integrity of the house isn’t compromised (when alternative is losing the house);
- There is a concern of institutional creep – where condos proliferate and expand, eventually in height, number of units etc;
- Ensure the Plan has “teeth”;
- Ensure the right people are applying and managing the process and enforcement of the plan;



- Implementation is critical, the process needs to be rigorous;
- Private property – let people do what they please if like with like;
- Review Permits / Heritage Permits – what is the cost? Length of time?
- There should be benefits when applying for variances, or a simplified process, when modifications conform to heritage planning/area part of restoration works;
- No purpose-use builds, condominiums, duplexes, and apartments;
- Residents MUST be involved in heritage permit approvals;
- Fear of setting the stage for neighbourhood conflict;
- Consider degree of permanence and reversibility in permit process;
- Neighbourhood review committee for demos and infill consider “why demolish?” “what will be replacing this building?”

### **The Building - Draft Guidelines**

- Consider how residents can afford to maintain and salvage buildings;
- Encourage “good” new design;
- Hydro now requires service be at front of existing and new buildings;
- Ensure a balance between contemporary and heritage homes;
- Height restrictions, materials, and garages should be regulated;
- Guidelines should focus less on architecture details and more on scale, massing, proportions etc.
- Consider succession planning in neighbourhood – in 10 years many of the older residents will have moved on, will sentiments remain consistent?
- Many homes already do not meet the proposed guidelines;

### **Windows and Doors**

- Restrictions on changing doors/windows is a bit “heavy handed” especially for newer homes;
- Flexibility for changing windows (making more energy efficient etc.) - the location, size of openings, orientations are the important elements to retain;
- Improve for heat, comfort, and efficiency;
- Difficulty in replacing original windows to exact size of pane (i.e. Might require 2-3 windows for one opening).

### **Roofs**

- Flexibility – there is already variation in roofing materials in The Point
- Maintain shape of roof;
- Is there a difference in permitting / regulations for homes from the 50's and earlier, compared with the older heritage homes?
- Keep solar panels, skylights, light tubes, and other equipment on the back of the roof so they are not visible from the street. If unavoidable, ensure placement on front of roof is tasteful and subdued.

## **Chimney**

- Retain original chimney, even if no longer in use (blocked in).

## **Cladding**

- Enable change;
- Conserve original stone and brick work;
- Leniency with newer materials – some may be preferred over originals, and still be in keeping with heritage character;
- Consider new / evolving technologies (ie. Metal roofs can be stylistically compatible with heritage character, It's not about the “materials” it is about the overall aesthetics).

## **Porches and Verandas**

- Few porches in the District can be considered “heritage” or “original”;
- Encourage restoration of heritage porches/verandas (use historic photos / record for reference);
- What if restoration works conflict with existing by-laws (such as set-backs).

## **Additions/Accessory Buildings**

- Concerned new additions will have to conform to existing buildings too strictly (i.e. Same cladding);
- Allow bungalows to be altered to allow another storey addition;
- Carport – closed in would require a permit.

## **Demolition**

- The issue of demolition had differing points of view from no demolition to some support for flexibility / leniency with demolitions;
- Allow demolition of bungalows for larger (2-3 storey) homes;
- Who decides when a demolition becomes necessary and repair is no longer “viable”?
- Prevent/address abandonment if possible;
- Maintenance guidelines – to prevent homes falling from into disrepair and becoming “unsalvageable properties” – to avoid “preventable” demolitions.

## **Infill**

- Avoid rebuilding / infill that is inappropriate to the district;
- Allow flexibility in Plan for infill and evolution;
- Encourage infill that follows guidelines/ is sympathetic to neighbourhood;
- Do not reject creative infill – address “ridiculous” interventions;
- Consider if infill buildings will fit better with district character.

## **The Site - Draft Guidelines**

### Trees

- Consider tree plantings. It is encouraged to plant trees, but removing them isn't acceptable – is this fair?

### Siting of Accessory Buildings

- Setback – recognize variation (consistent with existing);
- Make setbacks generous and sympathetic to adjacent;
- No buildings permitted in front yard;
- Keep “generous feel”/“pattern” created by setbacks, massing, buildings etc.

### Paved Areas

- Maximum green on front yards – consider permeable pavers (avoid using word “generous” in guidelines).

### Vehicle parking

- Consider on-street parking permits for residents;
- Consider requirement for a back-up lane in front property (even with rear / side parking).

## **The District - Draft Guidelines**

### Lot Pattern

- Do not encourage any subdivisions (even if it was a historic pattern);
- Do not permit layout alterations that aren't already in progress.

### Streets

- Encourage winter snow removal maintenance (blocking ends of sidewalks);
- Do not widen streets.

### Sidewalks

- No urgency to add more/ discourage new ones.

### Boulevards

- To be maintained;
- No curb cuts – do not to accommodate layby lanes or pull ins.

### Trees

- Guidelines for tree species - to encourage long living plant species for renewal;
- Encourage inter-planting of trees on boulevards and public property;
- Stronger language should be used in guidelines around tree planting and replacing;

- No incineration of trees by City on the riverbank as has been recent practice;
- An HCD should receive priority planting for loss of street tree collection due to age or disease;
- Tree maintenance guidelines are important;
- Hydro affects street trees – hydro should accommodate new street tree plantings not vice versa.

#### Parks and Open Spaces

- Incorporate policies relating to riverbank development;
- Maintain diversity between parks (i.e. East Blanchard, West Blanchard and Middle Gate extension);
- Request City to consider end of Middle Gate to be included as a park / open space.

#### Views, Vistas, and Approaches

- Redo approaches to the district to better define.

#### Utilities

- Shift utilities to adjust to streetscape;
- Plant 20' trees as an alternative under hydro - not ideal sol'n because loose the overall district impression of the tall tree canopy.

#### Signage and Lighting

- Encourage (unique) street signage (i.e. Wolseley);
- No commercial signs;
- Softer colour LED street lights – more ambient lighting;
- Consider shorter light poles if conflict with trees;
- Upgrade Park signage;
- Signage style consistency within district for park signs, street signs;
- Heritage + interpretive signage;
- Map of neighbourhood – offer wayfinding “you are here!”;
- Recognition of Heritage Conservation District (plaque).

## Public Open House – April 19, 2017



Location: 54 West Gate, Ralph Connor House, 4:00pm - 8:00pm

### Survey results

1. Overall, how satisfied are you with the process for developing a HCD Plan for Armstrong's Point?  
(7 responses).

- Very Satisfied – 71%
- Somewhat satisfied – 29%

2. How satisfied are you with following components of the HCD Plan?

#### District Boundary

- Very satisfied – 100%

#### HCD Policies and Guidelines

- Very Satisfied – 71%
- Somewhat satisfied – 29%

#### Work NOT Requiring a heritage permit

- Very Satisfied – 71%
- Somewhat satisfied – 29%

#### Heritage permit process

- Very Satisfied – 71%
- Somewhat satisfied – 14.5%
- Don't know – 14.5%

3. Please share with us any additional comments or concerns you have about Armstrong's Point HCD Plan.

- Overall I am very appreciative of the efforts of everyone who contributed to this project and I think, in future, the Draft Plan will effectively protect the heritage character of Armstrong's Point.
- Proposed plan limits development and retains residential character, which is good, but policies seem rather generic. Would prefer more emphasis on historical restoration.
- Please ensure variance guidelines are stronger than current (unenforced) City by-laws.
- Hoping residents continue to have a cooperative relationship with those enforcing the HCD and it does not become dictatorial.
- I live in Crescentwood and we have same problems as Armstrong's Point.